

EN

elecofire

BEYOND EXPECTATION

INSTRUCTION MANUAL

PELLET STOVE KIVA



**IMPORTANT:
MUST BE READ**



1. CREBUR LTD assumes no responsibility for damage to persons and/or property or for the malfunction of the stove resulting from non-compliance with the provisions of this Instruction Manual
2. The guarantee will remain valid for 1 year for professional operators and 2 years for consumers.
3. Stove installation must be carried out by qualified staff and pursuant to the regulations in force in the relevant country.
4. In the event of failed ignition or a power cut, before retrying the BURN POT MUST BE EMPTIED. Failure to do so may also result in the breaking of the door glass.
5. **DO NOT POUR PELLETS BY HAND** in the burn pot to facilitate stove's ignition.
6. Should any anomaly concerning the flame be detected or, however, in any other case, **NEVER SWITCH OFF** the stove by disconnecting it from the mains. Use the relevant button. Disconnecting the stove from the mains will prevent exhaust fumes from being extracted.
7. Should ignition phase take longer than expected (due to damp or poor quality pellets) generating excessive smoke in the combustion chamber, open the door to expel it, while remaining in a position that guarantees your safety.
8. **GOOD QUALITY, CERTIFIED PELLETS must always be used. The manufacturer declines any liability for any malfunctions or damage to mechanical parts as a result of the use of poor quality pellets.**
9. **The burn pot and the combustion chamber MUST BE CLEANED DAILY. The manufacturer declines any liability for any malfunctioning due to a failure to do so.**

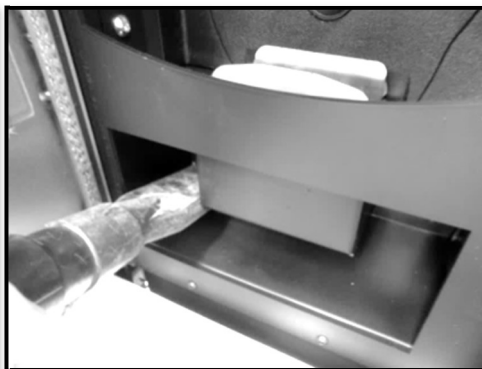
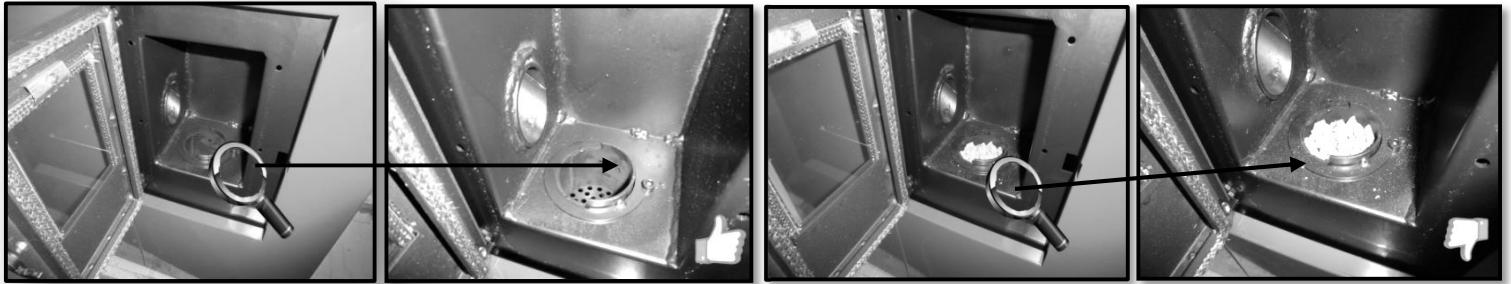

TABLE OF CONTENTS

01. PRODUCT SAFETY	4
02. GENERAL SAFETY PRECAUTIONS	4
03. MINIMUM INSTALLATION REQUIREMENTS	5
04. VENT PIPE	6
05. INSTALLATION WARNINGS	8
06. INSTALLATION	9
07. FLUE PIPE	10
08. INSTALLATION WARNINGS	10
09. INSTALLATION	10
10. ELECTRONICS WITH N.100 3 BUTTON LED DISPLAY	11
11. ALARMS	13
12. CLEANING AND ROUTINE MAINTENANCE	14
13. EXTRAORDINARY MAINTENANCE	14
14. TROUBLESHOOTING	15
15. YEARLY SCHEDULED MAINTENANCE	17
16. INTALLATION AND TEST CERTIFICATE	18

SAFETY WARNINGS

The stoves were built in compliance according to standard EN13240 (wood stoves), EN 14785 (pellet stoves) and EN 12815 (kitchens and wood-burning stoves) using high quality and non-polluting materials. To make better use of your stove it is advisable to follow the instructions in this booklet. Read this manual carefully before use or any maintenance operation.

CREBUR LTD aims to provide as much information as possible to ensure safer use and to avoid damage to persons, property or parts of the stove itself. Each stove is subjected to internal testing before shipment and as such residues inside the appliance may be found.

KEEP THE INSTRUCTION MANUAL FOR FUTURE REFERENCE
IF ANY CLARIFICATIONS ARE REQUIRED CONTACT YOUR AUTHORISED DEALER

- The combustion of waste, especially of plastic materials, damages the stove and the vent pipe. Moreover, it is forbidden by the law against the emission of harmful substances.
- Do not use alcohol, petrol or other highly inflammable liquids to light the fire or poke it during operation.
- Do not introduce into the stove an amount of fuel greater than that recommended in this booklet.
- Do not modify the product.
- It is forbidden to use the appliance with the door open or the glass broken.
- Do not use the appliance as, for example, a clothes drying rack, a bearing surface or step etc.
- Do not install the stove in bedrooms or bathrooms if not certified as watertight.

The pellets to be used are the following:

Pellet stoves operate exclusively with pellets (tablets) of various wood essences that comply with DIN plus or EN plus 14961-2 A1 or PEFC/04-31-0220 ONORM M7135 or that have the following characteristics:

Calorific value min. 4.8 kWh/kg (4180 kcal/kg)

Density 630-700 kg/m³

Maximum humidity 10% of weight

Diameter: 6 ±0.5 mm

Ash percentage: max. 1% of weight

Length: min. 10mm - max. 30mm

Composition: 100% untreated wood from the industry of wood or post-consumption without the addition of binders, bark-free and compliant with current regulations.

02. GENERAL SAFETY PRECAUTIONS

- Use the stove only as described in this manual. Any other use not recommended by the manufacturer may cause fires or accidents to people.
- Make sure that the electrical power available corresponds to the value indicated on the data plate (230V~/50Hz).
- This appliance is not a toy. Make sure children are not left unattended and do not use the appliance as a toy.
- This device is not intended for use by persons (including children) with reduced physical or mental capacity, or without specific experience and knowledge, unless supervised or duly instructed on the use of the appliance by a person responsible for their safety.
- Disconnect the appliance from the mains when not in use or during cleaning operations.
- To do so, turn the switch to the O position and disconnect the plug from the socket. Pull the plug, not the cable.
- Never block the combustion air inlets and fume outlets.
- Do not touch the stove with wet hands; it contains electrical components.
- **Do not use the appliance in case of damaged cables or plugs. The device is classified as type Y: power supply cable may only be replaced by a qualified technician. Should the power supply cable be damaged, it can be replaced only by the manufacturer or by its technical assistance service or by a similarly qualified person.**
- Do not place any object on the cable and do not bend it.
- Avoid using extension cables as their temperature may increase excessively posing fire hazards. Never use one single extension cable to power several appliances.
- **During normal functioning some parts of the stove may become extremely hot, such as the door, the glass or the handle. Be careful, especially with children. Do not touch any hot parts if not wearing adequate protective devices.**
- **ATTENTION! DO NOT TOUCH the FIRE DOOR, the GLASS, the HANDLE or the FUME OUTLET DURING FUNCTIONING if not wearing adequate protective devices since they become extremely hot!**
- Keep inflammable materials, such as furniture, cushions, pillows, blankets, paper, clothing, curtains, etc., at least 1.5 m away from the stove front and 30 cm from the stove sides and back.
- During operation, there is a risk of fire if the stove is covered or if it comes into contact with **flammable** material including curtains, draperies, covers, etc. **KEEP THE PRODUCT AWAY FROM SUCH MATERIAL.**
- Do not immerse the cable, plug or any other appliance component in water or other liquids.
- Do not use the stove in dusty environments or wherever inflammable vapours are generated (e.g. in a workshop or garage).
- The stove is fitted with components that generate arcs and sparks. Do not install the stove in areas posing a significant fire or explosion hazard due to a high chemical substance concentration or to a high humidity level.
- Do not use the appliance close to bathtubs, showers, basins, sinks or swimming pools.
- Do not install the appliance underneath an air vent. Do not install the stove outdoors.
- Do not repair, disassemble or modify the appliance. The appliance is not fitted with components that can be repaired by users.
- Turn off the stove, disconnect it from the mains and wait until it has cooled down completely before performing any maintenance operations.
- **WARNING: DISCONNECT THE STOVE FROM THE MAINS BEFORE PERFORMING ANY MAINTENANCE.**
- **ATTENTION! These stoves operate exclusively with pellets and olive pomace if the stove is designed for it; DO NOT USE DIFFERENT COMBUSTIBLES: any other material burned will cause the apparatus to malfunction.**
- **Keep the pellets in a fresh dry place: storing pellets in a place that is damp or excessively cold may reduce the stove potential heat output. Be careful when storing and handling pellet bags to prevent pellet crushing and consequent sawdust production.**
- The fuel consists of small cylinders with 6-7mm diameter and a maximum length of 30mm. Their maximum moisture content is equal to 8%. This stove is designed to burn pellets made of compacted sawdust obtained from different types of wood, in compliance with environment protection legislation.
- The use of different types of pellets may result in a slight, sometimes even undetectable, change in the stove efficiency. This change can be counterbalanced by increasing or decreasing the stove heat output by only one step.
- **Clean the burn pot on a regular basis upon every ignition or pellet refuelling.**
- The combustion chamber must be kept closed, except when loading or removing residues, in order to prevent smoke egress.
- Do not switch the stove on and off intermittently to avoid damaging its electrical and electronic components.
- Do not use the appliance as waste incinerator or for any other purpose other than the intended one.
- Do not use liquid fuels.
- Do not modify the appliance without prior authorisation.
- Use only original spare parts recommended by the manufacturer.
- Make sure that the stove is transported in compliance with safety regulations. Avoid any improper transfers or knocks that may damage the ceramics or the structure.

- The metal structure is coated using high temperature paints. When using the appliance for the first few times, unpleasant odours may be given off due to the paint of the metal parts that is drying: this is in no way dangerous and in such case, simply ventilate the premises. After the first heating cycles, the paint will reach its maximum adhesion and all its chemical and physical features.
- To refill the tank, simply lift the access cover and pour the pellets in, even when the machine is on, taking care not to spill outside of the tank. Always refuel the hopper before leaving the operating stove unattended for long periods of time.
- Whenever the hopper and the Auger tube get completely empty, the appliance will be automatically switched off. It may take two separate ignitions to resume operation at ideal working conditions since the Auger tube is very long.
- **ATTENTION! If the stove is not properly installed, power outages may result in fume spillages. In some cases, it may be necessary to install an uninterruptible power supply.**
- **ATTENTION! Being a heating appliance, some parts of the stove can become extremely hot. For precisely this reason, we advise that you take extreme care during operation.**

WHEN THE STOVE IS OPERATING:

- do not open the door;
- do not touch the door glass since it becomes extremely hot;
- keep children away from it;
- do not touch the fume outlet;
- do not pour any liquid inside the firebox;
- do not perform any maintenance operations if the stove is not cold;
- only qualified technicians are allowed to perform any operation;
- follow all the instructions contained herein.

Anti-explosion

Some products are equipped with anti-explosion safety devices. Before switching on the product or, in any case, after any cleaning operation, make sure that the device is correctly positioned in its seat. The device is located on the firebox door upper edge.



03. MINIMUM INSTALLATION REQUIREMENTS

INTRODUCTION:

INSTALLATION WITH WALL FUME OUTLET IS PROHIBITED. INSTEAD THE FUME OUTLET MUST BE ROOF-TYPE AS PROVIDED FOR BY NATIONAL REGULATIONS.

CREBUR LTD assumes no responsibility for damage to persons and/or property caused by non-compliance with the point highlighted above for products installed in a non-compliant manner.

Install the stove according to the regulations in force in the country of use.

For example, in Italy this refers to UNI 10683: 2012, which dictates 4 points:

a. preliminary activities - are under the jurisdiction and are the responsibility of the reseller/installer at the time of the pre-installation inspection. The preliminary activities include:

- installation site suitability verification;
- fume evacuation system suitability verification;
- external air inlet suitability verification.

At this stage it is necessary to check that the product can be safely operated and that it satisfies its technical characteristics.

The safety conditions must be assessed with a preventive inspection.

Stoves and fireplaces are heating systems and as such must be installed safely and according to the manufacturer's instructions!

b. installation - under the responsibility of the installer. In this phase the **installation** of the product and the smoke exhaustion system are considered as well as the handling of topics such as:

- **safety distance** from combustible materials;
- **chimney flue construction**, smoke ducts, intubated systems and chimney cowls.

c. issuance of supplementary documentation - the responsibility of the installer.

The production of technical documentation must include:

- manual of use and maintenance of the appliance and of the components of the system (e.g smoke ducts, chimney flue, etc.);
- Photocopy or photograph of the chimney flue plate;
- system manual: (if applicable);
- [Declaration of Conformity in relation to Ministerial Decree 37/08.](#)

4. control and maintenance - the responsibility of the maintenance technician who must oversee protection and maintenance of the product during its operation over time. The operator charged with checking and maintaining the systems for winter and summer climate control carries out activities in **a workmanlike manner** and in respect of applicable regulations. The operator, at the end of these operations, must draw up and sign a technical inspection report in accordance with the models provided by the provisions of this decree and the implementing rules, in relation to the type and capacity of the system, to be issued to the person who signs a copy thereby confirming receipt and reading thereof."

In addition to what is specifically provided for in the following paragraphs of this Instruction Manual, the Purchaser must comply with the following minimum installation requirements:

- Do not invert or place the stove horizontally on one side;
- The power of the stove must be adapted to the size of the room where it is to be installed and the room must be ventilated from the outside;
- The assembly of the flue pipe must be carried out in a workmanlike manner and according to European (UNI 10683) and national regulations, local regulations and the technical specifications and warnings contained in this Instruction Manual;
- The smoke outlet must be connected to the flue pipe by means of telescopic fittings;
- The diameter of the flue must be less than 150 mm.
- The connection to the flue pipe must be made with an inclination connection of less than 45°;
- Flue should not be insulated with vermiculite;
- The minimum length of the horizontal section must be greater than 2 metres;
- The minimum slope of the horizontal section must be 5%
- The chimney and/or flue pipe must be waterproofed;
- The flue shall not have more than two changes of direction;
- The flue gas must be discharged directly into the flue pipe;
- The flue gas duct must have a length of less than 6.0 m before the flue, with a maximum horizontal section of 3.0 m;
- The flue and flue duct must not narrow in width from the initial diameter for its entire length. The initial diameter shall be that of the exhaust outlet of the stove body;
- The minimum value of the ventilation duct opening must be 80 cm²;
- The distance of the flammable walls must be respected, as prescribed on the "stove data plate";
- The burn pot must be cleaned before each ignition of the stove.

The Buyer must not make any structural changes to the stove and must not make any operating changes to the electrical board.

Installation and connection must be carried out **by the Purchaser and by qualified technical personnel**, in compliance with European (UNI 10683) and national regulations, local regulations and assembly instructions contained in this Instruction Manual.

CREBUR LTD assumes no criminal and/or civil liability, direct and/or indirect, for damage to persons or property resulting from non-compliance with the aforementioned provisions of law, assembly instructions, warnings and general safety rules indicated in this Instruction Manual.

Failure to comply with the installation requirements and/or tampering with the stove may result in: inadequate power and/or abnormal product behaviour, poor flue gas draught, clogging of the fire pit, slow combustion, tank fire, overheating and fire hazard of the stove, fire hazard of the flue gas duct, lack of oxygen in the environment where the stove is located.

CREBUR LTD assumes no criminal and/or civil liability, direct and/or indirect for the malfunction of the stove and for damage to persons or property caused by non-compliance with the requirements for installation of the stove and/or tampering with it.

The Buyer must request and retain the certification of compliance of the installation, and the connection of the stove, with the provisions of law. In the absence of such certification CREBUR LTD assumes no criminal and/or civil liability, direct and/or indirect for the malfunction of the stove and for damage caused to persons or property, resulting from the use of the product.

Warning: in the event of a power failure or electrical blackout, the burn pot must be emptied before repeating the operation. Failure to follow this procedure may cause the door glass to break.

04. VENT PIPE

THE PRODUCTION OF STOVES WITH HIGHER PERFORMANCE IS INCREASINGLY REQUIRED SO IT IS BECOMES ESSENTIAL TO ENSURE THAT INSTALLATIONS COMPLY WITH THE LAW. IF THE VENT PIPE PASSES THROUGH NON-HEATED ENVIRONMENTS, IT MUST BE INSULATED FOR CORRECT COMBUSTION.

The vent pipe is one of the key features for guaranteeing the proper functioning of the stove. Thanks to the quality of the materials, the strength, the durability, the easy cleaning and maintenance, the best vent pipes are made of steel, either stainless steel or aluminised.

- The stove is fitted with a Φ 80mm rear round fume outlet and a joint connection to be connected to the vent pipe.
- To make fitting of the rigid steel flue pipe easier, we recommend using telescopic connectors, which will also compensate for the thermal dilation both of the fire box and the flue pipe itself.
- Seal the vent pipe joint connection with high temperature silicone sealant (1,000°C). Should the existing flue opening not be perfectly perpendicular to the firebox fume outlet, use an elbow to connect them. The inclination, with respect to the vertical, must never exceed 45° (see figure to the side) and there must be no bottlenecks.
- No constrictions. Use 10cm-thick insulating thimbles if pipe vent passes through floors.
- The vent pipe must be insulated along its entire length. Thanks to the vent pipe, insulation fume temperature will remain high optimising draught, preventing condensation and reducing the build-up of non-ignited particles along the vent pipe walls. Use proper insulating materials (glass wool, ceramic fibre, Class A1 non-combustible materials).
- The flue must be weatherproof and must not make more than two changes of direction.
- Flexible and length-adjustable metal pipes may not be used.

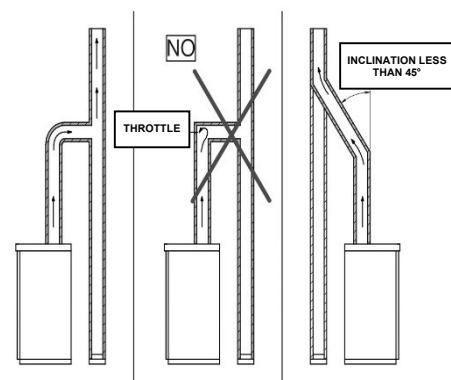

EXISTING VENT PIPE

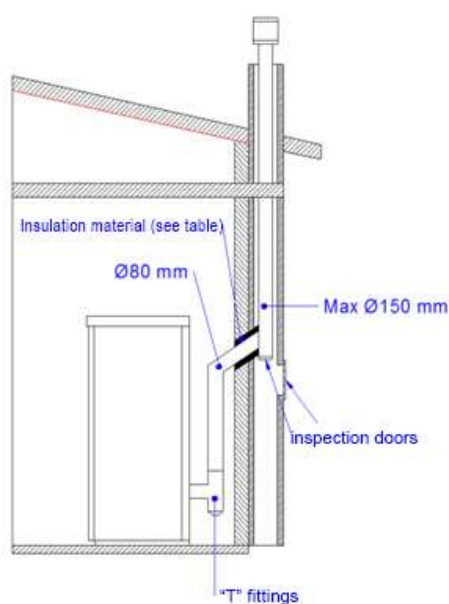

EXTERNAL VENT PIPE

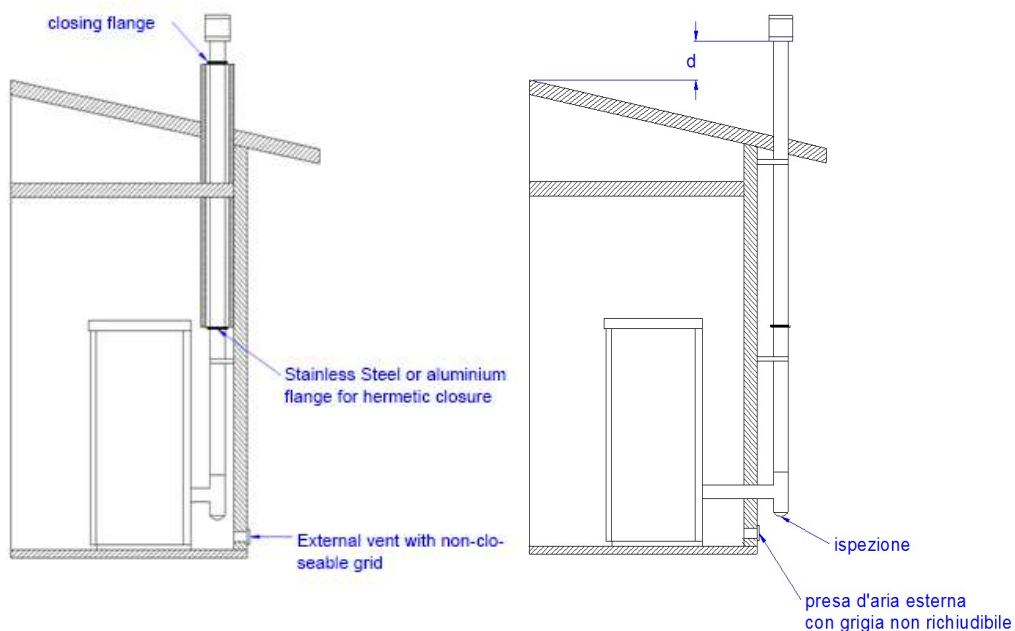

Types of vent pipe

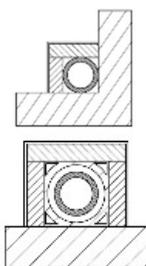

Steel vent pipe with double chamber insulated with material resistant to 400°C. Optimum efficiency.

Refractory vent pipe with insulated double chamber and external coating in lightweight concrete. Optimal efficiency.

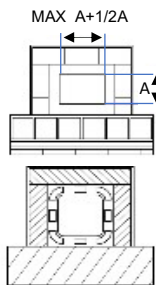

Avoid vent pipes with internal rectangular section whose ratio between the larger and smaller side is greater than 1.5. Poor efficiency

Traditional clay vent pipe with cavities. Optimal efficiency.

04.1 CHIMNEY COWL

A properly installed chimney cowl ensures optimum stove functioning. The anti-downdraught chimney cowl consists of a number of components whose outlet section sum always doubles the vent pipe section. Make sure the chimney cowl is at least 150cm above the roof top so that it is fully exposed to the wind.

The chimney cowls must:

- have useful outlet section that is at least twice that of the vent pipe.
- be made in such a way as to prevent the penetration of rain or snow.
- be constructed in such a way as to ensure, in the event of winds coming from any direction, the evacuation of combustion products.
- be free of mechanical intake auxiliaries.

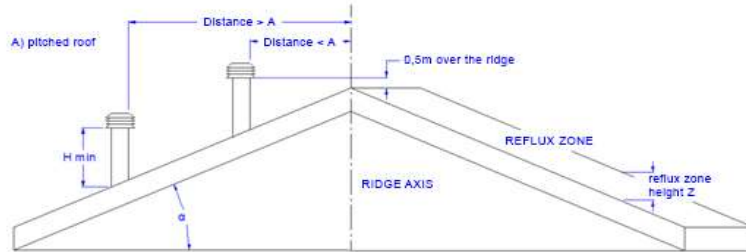
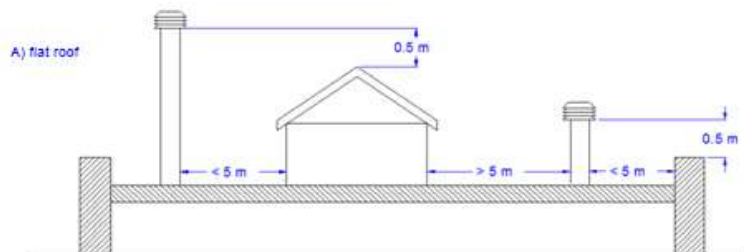
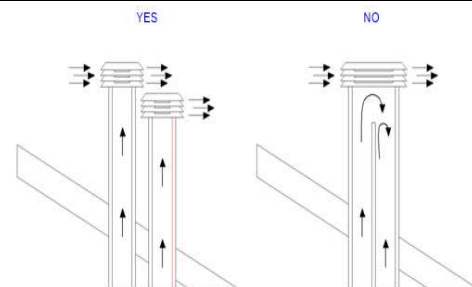

Roof pitch α [°]	Horizontal width of reflux zone measured from top A axis [m]	Minimum height from roof for discharging exhaust fumes $H_{\min} = Z + 0.50\text{m}$	Height of reflux zone Z [m]
15	1.85	1.00	0.50
30	1.50	1.30	0.80
45	1.30	2.00	1.50
60	1.20	2.60	2.10

04.2 DRAUGHT

Fumes heat up during combustion, increasing their volume. Their density is therefore lower than the one of the surrounding colder air.

This difference between the inside and outside temperatures of the chimney results in a negative pressure which increases proportionally to the vent pipe length and the temperature.

The draw of the vent pipe must be able to overcome all resistance from the smoke circuit so that any smoke produced inside the stove during combustion is drawn up and dispersed in the atmosphere through the discharge conduit and the vent pipe itself. There are many meteorological factors that influence the operation of the vent pipe, rain, fog, snow, altitude, but most of all is of course the wind, which can cause thermal depression as well as dynamic depression.

The wind action varies depending on whether it is ascending, descending or horizontal.

- Ascending wind always results in an increased negative pressure and draught.
- Horizontal wind results in an increased negative pressure as long as the chimney cowl was properly installed.
- Descending wind always diminishes the negative pressure, sometimes inverting it.

Excess draught causes an increase in the combustion temperature and consequently a loss in stove efficiency.

Some of the combustion gas as well as small particles of combustible are drawn into the vent pipe before being burned, reducing the stove's efficiency and increasing the consumption of pellets and causing the emission of polluting smoke.

At the same time the high fuel temperature, due to an excess amount of oxygen, wears down the combustion chamber sooner than expected.

On the other hand, poor draught slows down combustion resulting in a decrease in the stove temperature, fume spillage inside the room, a loss of stove efficiency and dangerous build-up in the vent pipe.

To avoid excessive draught it is advisable to use a draught regulator (see figure on the side).



04.3 STOVE EFFICIENCY

Highly efficient stoves may pose difficulties for fume extraction.

In order for a vent pipe to work properly its internal temperature must increase as a consequence of the fumes generated during combustion.

Now, the efficiency of a stove is determined by its capacity to transfer most of the heat produced into the area to be heated: the consequence of this is the greater the efficiency of the stove, the cooler the combustion smoke residues are and as a result the lesser the draught.

A traditional chimney flue, with a rough design and insulation, is more efficient if used with a traditional open fireplace or a poor quality stove where most of the heat is lost with the fumes.

Therefore, purchasing a quality stove often entails modifying the existing chimney flue to obtain a better insulation, even when it already works properly with old appliances.

Poor draught results in the stove not operating when hot or in smoke spillage.

- Connecting the stove pipe to an existing chimney flue that has already been used with an old appliance is a common mistake. In this way two solid-fuel appliances share the same chimney flue, which is wrong and dangerous.
- If the two appliances are used simultaneously, the fume load might exceed the existing chimney flue capacity resulting in downdraught. If only one appliance is used, the fume heat will facilitate draught but the cold air coming from the other appliance not in use will cool down exhaust fume temperature again blocking the draught.
- Besides the problems described so far, if the two appliances are placed on different levels the communicating vessel principle might be interfered with, causing combustion fumes to be drawn in an irregular and unforeseeable way.

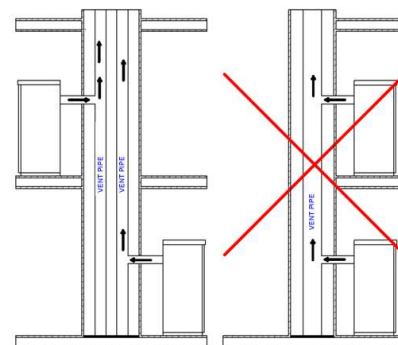

By using coaxial tubes, the air will be pre-warmed contributing to improved combustion and lower emissions into the atmosphere.

Before installing, the following indications must be met:
Select the position where the stove is to be installed and:

- Arrange the connection to the vent pipe for fume extraction.
- Arrange the external air intake (combustion air).
- Arrange the connection to the earthed mains.
- The electrical system of the room where the stove is to be installed must be earthed, otherwise the control board may not work properly.
- Place the stove on the floor in a convenient position for the connection to the vent pipe and close to the combustion air intake.
- The appliance must be installed on a floor with an adequate loading-bearing capacity.
- Should the existing floor not comply with the requirement above, proper measurements must be taken (for instance, the installation of a load distribution plate).
- All the structures which could catch fire if exposed to excessive heat must be protected. Floors made from wood or inflammable materials must be protected using non-combustible materials (e.g. 4mm-thick sheet metal or ceramic glass).
- The appliance installation must ensure easy access for cleaning the stove, exhaust pipes and vent pipe.
- This appliance is not suitable to be installed on a shared vent pipe.
- During normal operation, the stove draws air from the room where it is installed. Therefore, an external air intake must be positioned at the same height of the pipe located on the stove back. Exhaust fume pipes must be suitable for pellet stoves and must therefore be made from coated steel or stainless steel, with a diameter of 8cm and fitted with adequate gaskets.
- The "air combustion" socket must reach an external wall or a wall of an adjacent room with external ventilation, as long it is not a bedroom or bathroom, nor at risk of fire such as garages, storage rooms, combustibles stores, etc. These air vents must be made in such a way that they cannot be blocked either internally or externally and should be protected by a grille, e metal net or other suitable protection without reducing the minimum dimensions.

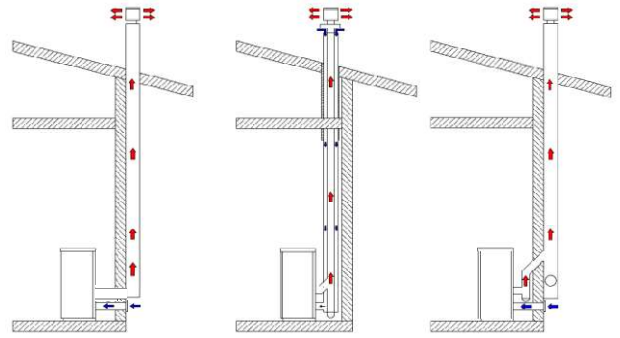

AIRTIGHT STOVE ONLY

Airtight stoves take combustion and glass cleaning air directly from outside, not from the room where they are situated, if correctly attached by a suction tube. In this way, no oxygen is consumed from the immediate environment. Using coaxial tubes the air will be pre-warmed contributing to improved combustion and lower emissions into the atmosphere. Ideal for passive houses, they offer best comfort at the lowest cost. The stove works even if not connected to the external air intake.

It is in any case advisable, as well as respecting minimum distances, to install the fireproof heat-resistant insulating panels (mineral wool, aerated concrete, etc.)
The following is recommend:

Promasil 1000	Specific heat capacity: 1.03 Kj/kg K
Classification temperature: 1000 °C	Thermal conductivity λ :
Density: 245 kg/m ³	200 °C → 0.07 W/mK
Shrinkage at reference temperature, 12 h: 1.3/1000°C %	400 °C → 0.10 W/mK
Cold crushing strength: 1.4 MPa	600 °C → 0.14 W/mK
Bending strength: 0.5 MPa	800 °C → 0.17 W/mK
Reversible thermal expansion: 5.4x10 ⁻⁶ m/mK	Thickness: 40 mm

- When the stove is on, it can create a depression in the room where it is installed, therefore there must not be any open flame apparatus in the same room, with the exception of type C boilers (airtight).
- Make sure that the stove can draw the necessary quantity of combustion air: this must be from an open space (i.e. a space without exhaust blowers or providing adequate ventilation) or directly from outside.
- Do not install the stove in bedrooms or bathrooms.
- Unpack the stove: be careful not to damage the product at the time of unpacking.
- Check the stove's legs and adjust them so that the stove is stable.
- Place the stove so that the door and any window openings are not against the walls.
- After connecting the stove to the combustion air inlet join the coupling device to the vent pipe.

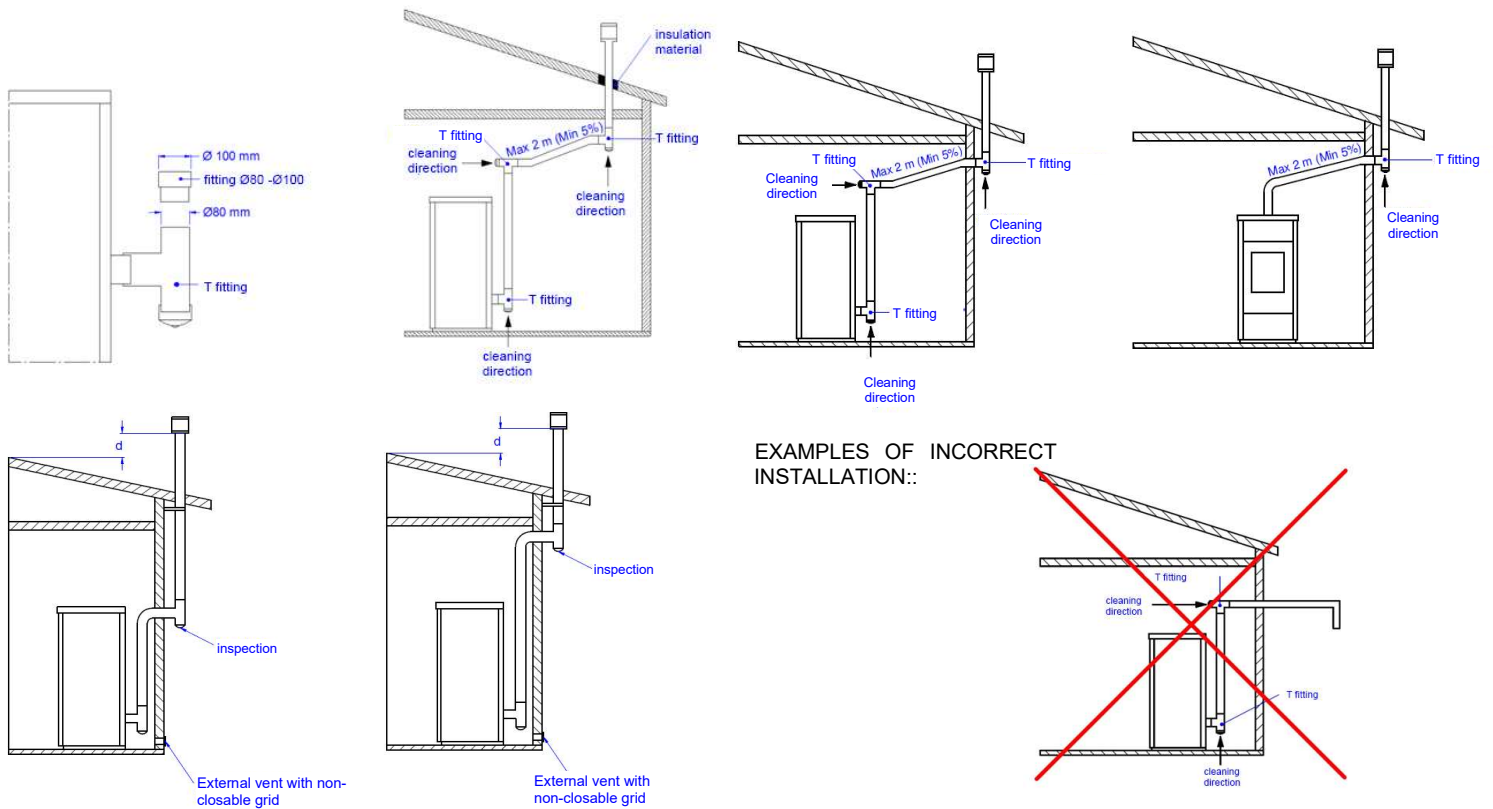

Exhaust pipes must never be fitted pointing downwards or horizontally so that fumes are discharged directly through the external wall.

06. INSTALLATION

06.1 HANDLING AND UNPACKING

When transporting do not position the product horizontally. Unloading of the product must be performed using lifting means that are suitable and that have characteristics that are consistent with the weight of the stove. The operator must make sure that during offloading and lifting of the stove there are no persons or objects nearby. When unpacking, avoid damaging the product with cutters or blunt tools. Keep the packaging out of the reach of children. Remove the screws of the brackets holding the product to the pallet and put it in position taking care to avoid anything that may block installation or damage the product. Use a lifter or pallet truck to separate the apparatus from the transport pallet using the appropriate opening on its base. Pay attention to the balance of the product given its size and weight.

06.2 PRIMARY AIR INTAKE AND POSITIONING

Observe the safety distances described above.

In compliance with the current regulations for installation, the stove must be installed in a ventilated place with air that is sufficient to ensure correct combustion and therefore good operation.

The room must have a volume no less than 20 m³. In order to ensure good combustion (40 m³/h of air) there must be a "combustion air intake" that reaches an external wall or a wall of an adjacent room with an external air intake. The adjacent room must not be a bedroom, bathroom, or contain any fire risks, such as storerooms, garages, combustible materials stores, etc. These air intakes must be made in such a way as to avoid being blocked internally or externally, and should be covered with a grille, metal net or suitable protection, as long as the minimum diameter is not reduced.

When the stove is on, it can create a depression in the room where it is installed, therefore there must not be any open flame apparatus in the same room (with the exception of type C boilers (airtight), unless there is a suitable influx of air).

The stove must not be positioned close to curtains, armchairs, furniture or to other flammable materials.

The stove must not be installed in explosive or potentially explosive environments which may become explosive due to the presence of machinery, materials or dust that can cause greenhouse gas emissions or which can easily ignite with sparks. Before installing the pellet stove, it must be borne in mind that all finishes or any beams made of combustible material must be positioned at a suitable distance and outside the irradiation area of the stove itself; furthermore, it must be borne in mind that in order not to compromise the correct operation of the appliance air must be allowed to circulate inside its housing to prevent overheating, this is possible by respecting the minimum distances and making ventilation holes with a surface area of 80 cm².

06.3 FUME EXHAUST CONNECTION

When drilling the hole for the passage of the exhaust pipe it is necessary to take into account the possible presence of flammable materials. If the hole must pass through a wooden wall or in any case a wall made of thermolabile material, the installer must use a wall connection and adequately insulate the pipe of the product that passes through it using suitable insulating materials (1.3 - 5 cm thick with a minimum thermal conductivity of 0.07 W/m²K).

The same minimum distance must be respected even if the exhaust pipe has to pass through vertical or horizontal sections near the flammable wall.

06.4 ELECTRICAL CONNECTION

The electrical connection must be performed by qualified personnel who install circuit breakers upstream of the appliance.

Special attention should be paid when the operation is a supplementary action and all equipment must operate as planned.

Avoid installations with electric cables that run close to fume pipes or hot components that are suitably insulated.

The voltage is 230 V while the frequency is 50 Hz.

The electrical system, at the connection point, must have a ground connection as required by EEC Regulation 73/23 and EEC 93/98.

01.1 FLUE PIPE CHARACTERISTICS

PELLET STOVE 8 KW (9) SPCT8	
Chimney flue draught	12 Pa
Fume temperature	214 °C
Maximum flue smoke flow	6,1 g/s

08. INSTALLATION WARNINGS

- If the stove is to be installed in rooms where it is surrounded by combustible materials (e.g. furniture, wood cladding, etc.), **the following minimum clearances must be complied with:**

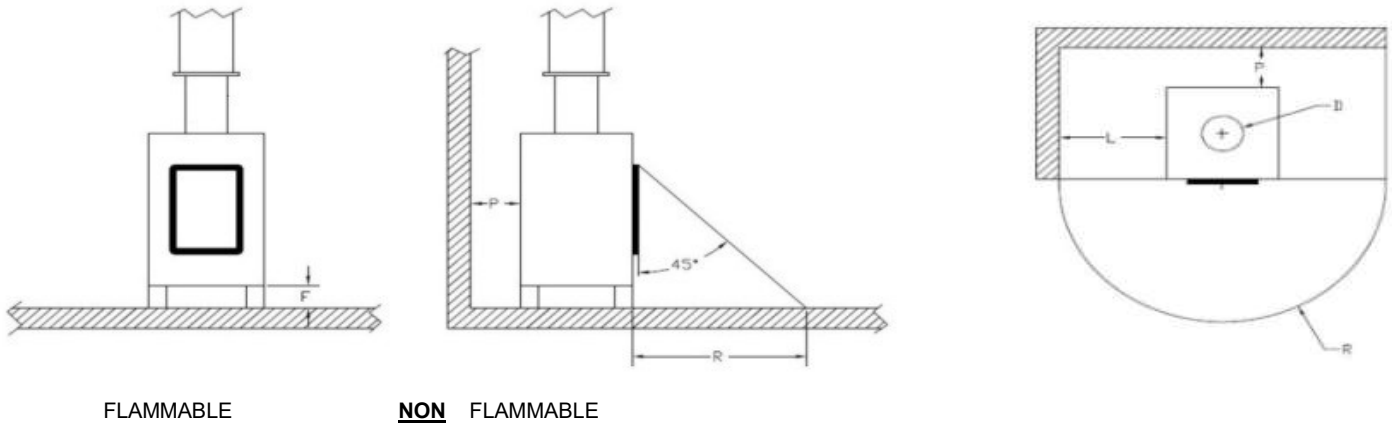
STOVES and BOILERS

FLAMMABLE

NON FLAMMABLE

PELLET STOVE 8 KW (9) SPCT8

REAR WALL P =	100 mm
SIDE WALL L =	250 mm
FLOOR F =	- mm
FRONT R =	1000 mm

PELLET STOVE 8 KW (9) SPCT8

REAR WALL P =	100 mm
SIDE WALL L =	150 mm
FLOOR F =	- mm
FRONT R =	1000 mm

09. INSTALLATION

09.1 TRADITIONAL PELLETS STOVES

IMPORTANT: THE LENGTH OF THE SMOKE DUCT MUST BE A MAXIMUM OF 6 METRES OF 80 mm DIAMETER TUBE AND EACH 90° BEND OR (T) CONNECTION MUST CORRESPOND TO 1 METRE OF TUBE

TO GUARANTEE THE CORRECT OPERATION AND YIELD OF ALL OUR PELLETS ITEMS, BEFORE CARRYING OUT A CONNECTION TO THE FLUE PIPE INSTALL A T-CONNECTION AND AT LEAST 1 LINEAR METRE OF SMOKE DUCT CERTIFIED IN ACCORDANCE WITH EN1856-2



TECHNICAL DATA

		KIVA	
Fuel throughput	Kg/h	2.0	0.6
Necessary flue draught	Pa	12	10
Flue gas temperature	°C	213	105
Flue gas mass flow	g/s	6.1	3.5
Efficiency	%	88.0	90.0
Total heating output	kW	8.0	2.5
Space heating output	kW	8.0	2.5
CO emission at 13% of O ₂	%	0.010	0.013
Electrical power supply	W	320	
Rated voltage	V	230	
Rated frequency	Hz	50	

10.1 CONSOLE

Console

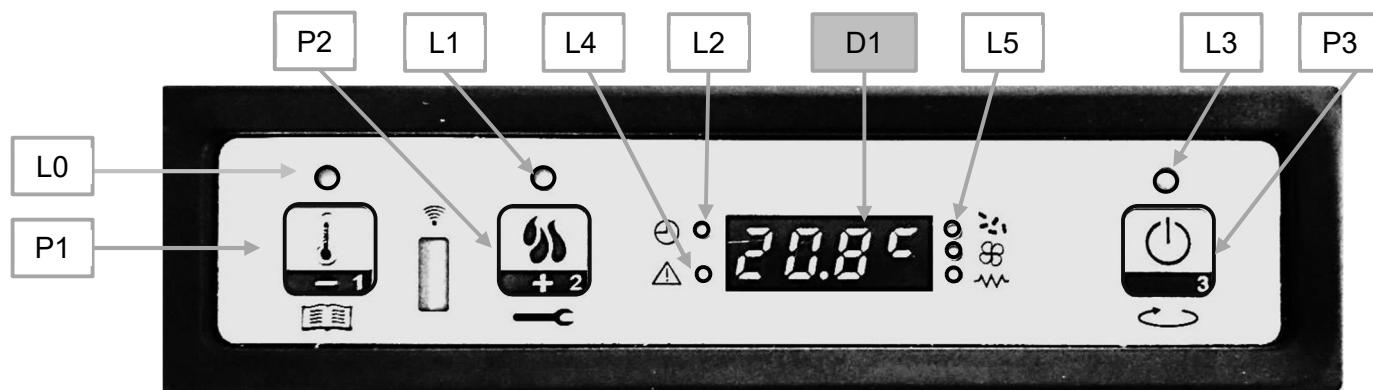

The control board can be managed by simply pressing a few buttons on the control panel.

A display and the LED indicators inform about the stove operational status. When in programming mode all the parameters that can be modified using the buttons are shown on the display.

PANEL DESCRIPTION

LED (L0) set room

LED (L1) set heat output

LED (L2) chrono

LED (L3) ON/OFF

LED (L4) alarm

LED (L5) auger/exchanger/glow plug

Button (P1) decrease/menu/set room temperature

Button (P2) increase/stove status/set heat output

Button (P3) ON/OFF/ esc/confirm

Display (D1) status/heat output/parameter

10.2 MENU

MENU

Hold P1 button down to access the menu.

It includes several items and levels to access settings and control board programming.

Menu M1 – SET CLOCK

Keep button (P1) pressed until message M1 appears, confirm with the ON/OFF button (P3), with buttons (P1) and (P2), change the current day and press the ignition button; set the hour and press ON/OFF (P3); set the minutes and press ON/OFF (P3); set the current day as a number and press ON/OFF (P3), set the current month and press ON/OFF (P3), set the current year; to confirm and exit keep the ON/OFF (P3) button pressed until the time reappears.

Menu M2 – SET CHRONO**Sub-menu M2 – 1 CHRONO ENABLE**

Keep button (P1) pressed until message M1 appears, press the (P2) button up to M2, confirm with ON/OFF button (P3); the menu M2-1 appears, confirm with ON/OFF (P3) and with the arrow (P1) set ON to activate the general chrono; go back keeping ON/OFF (P3) pressed, with button (P2) choose the programme to enable.

Sub-menu M2 – 2 PROGRAM DAY

Two fixed ON/OFF cycles for each day.

Sub-menu M2 – 3 PROGRAM WEEK

Four ON/OFF cycles and the days must be selected for each time

Sub-menu M2 – 4 PROGRAM U-END

Two ON/OFF cycles for Saturday and Sunday

Setting a programme

Enter the desired programme by pressing ON/OFF (P3) once. The first parameter is the enabling of the programme itself, which should be set to ON by pressing the (P2) button (**CAUTION: ENABLE ONE PROGRAMME AT A TIME TO PREVENT ISSUES WITH THE CHRONO**). Press ON/OFF (P3), to set the START time, with buttons (P1) and (P2) enter the desired switch-on time; press SET (P3) to set the STOP time: with arrows (P1) and (P2) set the switch-off time; only for the weekly program, press SET (P3) with the days requiring confirmation, with the ON/OFF button, navigate between the days of the week and with buttons (P1) and (P2), set ON or OFF. Once the times and days have been set, to confirm and exit the chrono, press and hold the ON/OFF button until the initial screen is seen; if the times have been set correctly, a green LED will illuminate near the clock at the top left of the display.

Menu M3 – LANGUAGE

Use this command to select one of the languages available. Press P2 (increase) and P1 (decrease) buttons to scroll through the options and press P3 button to confirm.

Menu M4 – STAND-BY

Use to enable or disable Stand-by mode. Press P3 button to select menu M4 and then P1 (decrease) or P2 (increase) button to select the ON or OFF status.

Menu M5 – BUZZER

Allows the controller buzzer to be enabled or disabled during alarm signalling. Press the P1 or P2 button to enable or disable this command and P3 to confirm.

Menu M6 – INITIAL LOAD

This command is only available when the stove is **OFF** and allows the auger tube to be loaded the first time the stove is started when the pellet hopper is empty. After selecting the INITIAL LOAD menu, "Press more" will scroll on the display. Then press P2 (increase). The exhaust blower switches on at the maximum speed and the auger tube (auger tube LED on) starts working. They will switch off once the period of time indicated on the display has elapsed or after pressing the P3 button.

Menu M7 – STATE STOVE

After entering menu M7 by pressing P3 button, the status of a number of parameters with stove in working mode scrolls on the display. The table below contains an example of the scrolling values on the display including their meaning.

Displayed status – Meaning

3.1" - Pellet loading auger status	52' - Time out	Toff - Thermostat status	106° - Flue gas temperature	1490 - Flue gas extraction speed
------------------------------------	----------------	--------------------------	-----------------------------	----------------------------------

Menu M8 – SET TECHNIC

This menu item is reserved for the stove installer. After entering the access key using buttons P1 (decrease) and P2 (increase), the various operating parameters of the stove can be set.

Menu M9 – ESCAPE

Selecting this item, pressing button P3 will exit the menu and return to the previous status.

10.3 USER FUNCTIONS

Standard functioning of a control board properly installed on an air stove is described below with reference to the functions available to users.

Stove ignition

First connect the stove plug to the mains and load the pellet hopper.

Be careful not to empty the entire bag at once. Perform this operation slowly.

The combustion chamber and the burn pot must be cleaned, removing any combustion residue. Verify that the hopper lid and the door are closed. Failure to do so could cause a malfunction of the stove and subsequent related alarms. Upon initial start-up ensure that in the burn pot there are no components that will burn (feet bag, instructions, etc.).

Hold P3 button down for a few seconds to switch on the stove. The successful switching on procedure is indicated in the display with the message "START" and the flashing ON/OFF LED. This phase lasts for the time given by parameter Pr01.

During this phase, the stove goes into pre-heating status; both the glow plug (as indicated by the corresponding L5 glow plug LED) and the exhaust blower switch on.

Any problem detected during the switching-on phase is indicated on the display and the stove goes into alarm status.

Pellet loading

After approx. 1 minute, the pellet loading phase begins, the display shows the message (LOAD PELLETT) and the ON/OFF LED illuminates intermittently. During the first stage, the auger tube feeds the pellets to the burn pot during a period of time set by the Pr40 parameter (auger tube LED on), the exhaust blower speed is set by the Pr42 parameter and the glow plug is still on (glow plug L5 on).

In the second phase, once the time of parameter Pr40 has elapsed, the auger switches off (LED auger L5 off) for a time given by parameter Pr41, while the exhaust blower speed and the glow plug remain in the previous state.

In case of ignition failure at the end of this phase, the auger tube switches back on and stays on during the period of time set by the Pr04 parameter, the exhaust blower speed is set by the Pr16 parameter and the glow plug stays on.

Fire present

Once the fume temperature has reached and exceeded the Pr13 parameter value, the stove goes into ignition mode: the message (FLAME LIGHT) appears on the display and the ON/OFF LED begins to flash.

In this phase, the temperature remains stable for a preset time as set by the Pr02 parameter.

The exhaust blower speed is set by the Pr17 parameter, the Auger tube stays on for a period of time set by the Pr05 parameter (Auger tube LED flashing) and the glow plug is off (glow plug LED off).

Any problem during this phase will cause the control board to stop and the stove to go into error state.

Stove operational

Once the fume temperature has reached and exceeded the Pr13 parameter value, maintaining it for a period of time set by the Pr02 parameter, the stove enters normal working mode. The message (UORK) appears on the display and the ON/OFF LED switches on. The heat output can be set by pressing the P2 key and the room temperature can be set by pressing the P1 button.

If the fume temperature reaches the threshold set by parameter Pr15, the air exchanger fan switches on. (exchanger LED lit)

IMPORTANT: During this phase, after a period of time set by the Pr03 parameter, the stove carries out burn pot cleaning. The message "CLEANING FIRE-POT" scrolls on the display, the Auger tube is on (corresponding LED illuminated) at a speed set by the Pr09 parameter and the exhaust blower at a speed set by PR08 parameter. Once a time set by the Pr12 parameter has elapsed, the stove returns to working status (**this procedure does not apply to 4 KW stoves**).

Changing set heat output

During normal operation of the stove (UORK), heat output can be changed by using the P2 button. (Set heat output LED on).

Press P2 button again to increase the heat output and P1 button to decrease it. The display will show the set heat output.

Do not press any button for 5 seconds or press P3 button to exit the setting mode.

Changing set room temperature

Press P1 button to change the set room temperature.

The display shows the set room temperature (SET temperature value). Press P1 and P2 buttons to decrease or increase, respectively, the temperature value. The value is saved after approx. 5 seconds and the display goes back to normal. Otherwise, press P3 to exit.

Room temperature reaches the set value (SET temperature)

When the set room temperature value is reached, the stove heat output is automatically set to the minimum value. During this phase, the display shows the message "MODULAT". If the room temperature falls below the set value (Set temperature), the stove will go back to the "UORK" mode and to the previously set heat output (Set heat output).

Stand-by

When enabled in the menu, the STAND-BY command allows the stove to be switched off after complying with the following conditions.

This is enabled if, for a time, given by parameter Pr44, the room temperature is higher than the set temperature (Room set) plus parameter Pr43.

The display shows "GO-STBY", followed by the remaining time in minutes. At the end of the period of time set by the Pr44 parameter, the message "UAIT COOLING" appears on the display. In this mode, the stove's auger is off (auger LED off), the exchanger switches off when the threshold given by parameter Pr15 is reached and the ON/OFF LED flashes. When the fume temperature reaches the threshold set by the Pr13 parameter, the stove goes into STAND-BY mode and the message "STOP ECO TEMP GOOD" scrolls on the display. The Auger tube (auger tube LED off), the exchanger (exchanger LED off) and the exhaust blower are off. If the room temperature falls below the set value (Set room temperature) plus the threshold set by the Pr43 parameter, the stove switches back on.

Stove switch off

Hold P3 button down to switch off the stove. The display shows the message "CLEANING FINAL".

The auger tube motor switches off (auger tube LED off), the exhaust blower speed is set by the Pr08 parameter and the ON/OFF LED flashes.

The fan of the exchanger (exchanger LED on) remains active until the fume temperature falls below the value set in the parameter Pr15. After a time given by the PR39 parameter, if the fume temperature is below the threshold given by the parameter Pr10, the stove switches off, displaying the message "OFF".

External thermostat/chrono-thermostat use

If an external room thermostat is to be used, make the connection to the TERM terminals.

- **external thermostat:** carry out a temperature SET in the stove equal to T-E.
- **external chrono-thermostat:** carry out a temperature SET in the stove equal to T-E and disable (OFF) the chrono

The stove external thermostat is enabled when the contact is closed with stove on.

In the event that an operating fault occurs, the board intervenes and signals the occurrence of an irregularity, switching on the alarm LED (alarm LED on) and emitting acoustic signals.

In case of alarm, the stove is always immediately switched off

EXCEPT FOR THE POWER OUTAGE ALARM, alarm status is reached at the end of the period of time set by the Pr11 parameter and can be cleared by holding the P3 button down. Whenever an alarm is cleared, the stove starts a switching-off phase for safety reasons. The alarm LED (alarm LED on) will remain on and the buzzer, if enabled, will sound intermittently during the entire alarm phase. Should the alarm not be cleared, the stove will in any case be switched off and the alarm message will remain on the display.

AL1 BLAC-OUT – Power outage alarm

Power outage may occur with the stove in working mode. When restarting, if the outage period is less than 20 seconds, the stove restarts in **WORKING** mode, otherwise an alarm will sound. The display shows the message “AL1 POWER OUTAGE” and the stove switches off.

AL2 PROBE EXHAUST– Fume temperature probe alarm

The alarm is triggered in case of faulty fume probe. The stove goes into alarm status and the alarm LED illuminates (LED alarm on). The stove will show the wording “AL2 FUME PROBE” on the display and will switch off.

AL3 HOT EXHAUST – Fume over-temperature alarm

This occurs if the fume probe detects a temperature greater than a fixed set value that cannot be changed using a parameter. The display shows the message “AL3 HOT FUMES” and the stove switches off.

AL4 FAN FAILURE – Fume encoder fault alarm

The alarm is triggered in the event of an exhaust blower fault. The stove will go into alarm status and the message “AL4 EXTRACTION FAULT” will appear on the display.

AL5 NO LIGHTIN- – Ignition fault alarm

The alarm is triggered in the event of ignition phase fault. This occurs if, after a time given by parameter Pr11, the fume temperature does not exceed parameter Pr13. The display shows “AL5 IGNITION FAULT” and the stove goes into alarm status.

AL6 NO PELLETS – No pellets alarm

This occurs when the fume temperature falls below parameter Pr13 during operation. The display shows “AL6 NO PELLETS” and the stove goes into alarm status.

AL7 SAFETY THERMAL – Thermal safety over-temperature alarm

The alarm is triggered whenever the general safety thermostat detects a temperature exceeding the trigger threshold. The thermostat trips and switches off the auger as it is placed in series with its power supply, and the controller trips by signalling alarm status (alarm LED on), showing “AL7 THERMAL SAFETY” on the display, and the stove switches off.

AL8 FAILURE DEPRESS – No negative pressure alarm

This occurs when the external component (pressure switch) detects a pressure above the trigger threshold. The pressure switch intervenes by switching off the auger, being electrically connected in series, and the controller signals alarm status (alarm LED on) showing “AL8 NO NEG. PRESSURE” on the display. The stove switches off.

SERVICE MESSAGE

The stove will display the message SERVICE (or SER) during operation depending on the number of hours of operation. The wording does not lock operation of the stove, but non-routine maintenance will be required by an authorised technician, who will reset the service hours.

IR REMOTE CONTROL (IF INCLUDED OR SUPPLIED AS OPTIONAL)

IR REMOTE CONTROL (OPTIONAL)

The control panel of the stove has been set up to receive a number of commands via remote control.

- On/off command: pressing the two buttons marked “1” and “6” simultaneously switches the stove on or off.
- Heat output adjustment: during normal working mode, pressing buttons “5” and “6” marked with a flame, sets one of the heat output levels of the stove.
- Temperature adjustment: during normal working mode, pressing button “2” and then buttons “1” and “2”, marked with a thermometer, sets the desired temperature.



12. CLEANING AND ROUTINE MAINTENANCE

The stove requires simple and frequent cleaning to guarantee maximum efficiency and correct operation.

The Buyer must carry out regular cleaning of the stove following the instructions contained in this Instruction Manual, and in particular must carry out daily cleaning before each ignition or refilling of pellets, the ash drawer, the fire pit and the combustion chamber.

Failure to clean and/or routinely maintain the stove can cause: malfunctions, clogging of the burn pot and pipes, poor or slow combustion, overheating of the stove and fire in the tank.

CREBUR LTD assumes no criminal and/or civil liability, direct and/or indirect for the malfunction of the stove and for damage to persons or property caused by the failure/incorrect cleaning and routine maintenance of the stove.

Perform daily cleaning in a completely cold stove as follows:

- Vacuum the base of the fire pit inside the combustion chamber

Perform weekly cleaning in a completely cold stove as follows:

- Vacuum the combustion chamber, ensuring that there are no burning embers remaining. If embers are still burning, the vacuum cleaner will catch fire;
- Remove the ash that collects inside the fire box and on the door.
- Clean the glass with a damp cloth or with a ball of damp newspaper dipped in ash. If the operation is performed with the stove hot there is a risk of the glass exploding.
- Empty the ash drawer, by vacuuming it or throwing the ash out with the rubbish.
- Vacuum the ash drawer compartment and the adjacent inspection window.

Perform monthly cleaning in a completely cold stove as follows:

- Vacuum the T lid of the fume connection. Open the side inspection window and remove the T lid.



Caution: Only use a dry cloth to clean the stove. Do not use abrasive material or products that could corrode or bleach surfaces. At the end of the season, with the last ignition, the pellet remaining in the auger must be consumed completely. The auger must remain empty to avoid clogging due to solidified sawdust residue created by moisture.

13. EXTRAORDINARY MAINTENANCE

The Buyer must have the flue and flue pipe cleaned annually, before winter, by qualified technical personnel and retaining the documentation to be shown in the event of activation of the warranty.

Before performing maintenance it is recommended to turn the stove off using the power button, and remove the plug.

Cleaning must also be carried out before resuming use of the stove, as during the summer there may have been impediments to the regular flow of exhaust gases (e.g. nesting, fouling or obstruction).

The lack of extraordinary maintenance can cause: depression with poor draught and a slow flame, clogging of the burn pot and pipes, overheating of the stove and fire in the smoke pipe.

CREBUR LTD assumes no criminal and/or civil liability, direct and/or indirect for the malfunction and those resulting from people or things caused by the failure/incorrect extraordinary maintenance of the stove.

It is not uncommon, at the first cold spell and with wind for fires to ignite in the chimney due to the residue build up; some advice in the unfortunate event of this happening is:

- Block air supply to the pipe immediately;
- Use large handfuls of sand or salt, not water, to extinguish the fire;
- Move objects and furniture away from the hot chimney.

Caution: Only use a dry cloth for cleaning the outside of the stove. At the end of the season, with the last ignition, the pellet remaining in the auger must be consumed completely. The auger must remain empty to avoid clogging due to solidified sawdust residue created by moisture.

14. TROUBLESHOOTING

PROBLEM	CAUSE	SOLUTION
FIRST START-UP	IT MAY BE NECESSARY TO REPEAT THE FIRST LOAD PHASE A FEW TIMES TO FACILITATE THE APPLIANCE INITIAL START-UP AS THE AUGER TUBE IS COMPLETELY EMPTY AND IT MAY TAKE A SPECIFIC PERIOD OF TIME TO FILL.	
DISPLAY SWITCHED OFF	POWER OUTAGE	CHECK PLUG AND POWER SUPPLY OR ON/OFF SWITCH
	FAULTY ELECTRICAL CABLE	CALL TECHNICAL ASSISTANCE.
	INTERRUPTED FUSE IN CONTROL BOARD	CALL TECHNICAL ASSISTANCE.
	FAULTY CONTROL BOARD	CALL TECHNICAL ASSISTANCE.
	FAULTY DISPLAY	CALL TECHNICAL ASSISTANCE.
ALAR COOL FIRE ACTIVE ALARM MISSING PELLETS ACTIVE ALARM NOT ON - AL6 MISSING PELLETS AL6 NO FLAME NO FLAME	POWER OUTAGE	CHECK PLUG AND POWER SUPPLY.
	NO PELLETS	CHECK TANK.
	AUGER TUBE BLOCKED BY FOREIGN BODY	DISCONNECT PLUG, EMPTY HOPPER, REMOVE ANY FOREIGN BODY, SUCH AS NAILS, ETC.
	POOR QUALITY PELLETS	CHANGE PELLET TYPE.
	INSUFFICIENT PELLET SET VALUE AT MINIMUM HEAT OUTPUT	CALL TECHNICAL ASSISTANCE.
	POWER OUTAGE	SWITCH STOVE ON AND OFF, CHECK PLUG.
ALAR NOT ON ACTIVE ALARM NOT ON - AL5 FAILURE TO TURN ON NO STAB	NO PELLETS	CHECK TANK.
	SAFETY THERMOSTAT TRIGGERED	MANUALLY RESET THE THERMOSTAT LOCATED ON STOVE BACK
	FAULTY FUME SENSOR	CALL TECHNICAL ASSISTANCE.
	AUGER TUBE BLOCKED BY FOREIGN BODY	DISCONNECT PLUG, EMPTY HOPPER, REMOVE ANY FOREIGN BODY, SUCH AS NAILS, ETC.
	FAULTY AUGER TUBE MOTOR	CALL TECHNICAL ASSISTANCE.
	FAULTY CONTROL BOARD	CALL TECHNICAL ASSISTANCE.
	FAULTY EXHAUST BLOWER	CALL TECHNICAL ASSISTANCE.
	DIRTY BURN POT	CLEAN BURN POT.
	TEMPERATURE TOO COLD	REPEAT SWITCHING-ON PHASE SEVERAL TIMES, EMPTYING THE BURN POT UPON EACH TIME.
	DAMP PELLETS	CHECK PELLET STORAGE LOCATION.
FAULTY IGNITION PLUG	CALL TECHNICAL ASSISTANCE.	
ALAR COOL FIRE AL1 BLAC-OUT	DURING OPERATION THE ELECTRICITY SUPPLY WAS CUT OFF	IF FOR MORE THAN 20 SECONDS THE STOVE GOES OFF/BURN POT CLEANING IF FOR LESS THAN 20 SECONDS THE STOVE RESTARTS IN OPERATING MODE
BURN POT CLEANING	WARNING THAT APPEARS AFTER 8 HOURS OF STOVE OPERATION (4/5 KW MODELS ONLY) 8 HOURS ARE CUMULATIVE	TO CLEAR THE WARNING, PRESS ALL 3 BUTTONS ON THE DISPLAY FOR 4-5 SECONDS
IRREGULAR SLOW FLAME DIRTY GLASS	ANTI-EXPLOSION DEVICE PLUG MISSING OR NOT CORRECTLY POSITIONED.	
	PARTIALLY CLOGGED VENT PIPE	CLEAN VENT PIPE IMMEDIATELY.
	COMBUSTION AIR NOT SUFFICIENT	SUCTION PIPE CLOGGED.
	CLOGGED STOVE	CLEAN BURN POT AND ASH DRAWER.
	FAULTY / DIRTY EXHAUST BLOWER	GET IT CLEANED BY A SPECIALISED TECHNICIAN CALL TECHNICAL ASSISTANCE.
	INADEQUATE COMBUSTION AIR SET VALUE	CALL TECHNICAL ASSISTANCE.
ALAR FAN FAIL ASPIRAT-FAULT ACTIVE ALARM AL4 ASPIRAT-FAULT AL. FAN	FAULTY OR DEFECTIVE FUME FAN	CALL TECHNICAL ASSISTANCE.
	THE BOARD DOES NOT HEAR THE MOTOR RUNNING (DEFECTIVE BOARD)	CALL TECHNICAL ASSISTANCE.
ECO/MODULE	REACHING THE SET AMBIENT TEMPERATURE/ CORRECT OPERATION, THE STOVE WORKS AT POWER LEVEL 1. INCREASE SET ROOM TEMPERATURE SO THAT APPLIANCE GOES BACK TO "WORKING" MODE.	
STOP FIRE CLN-BURN POT CLEAN BURN POT BURN POT CLEANING	PERIODIC CYCLE OF BURN POT CLEANING	CORRECT OPERATION.
STAND-BY / ECO STOP / PAUSE	REACHING SET AMBIENT TEMPERATURE / CORRECT OPERATION	
ALAR DEP FAIL ACTIVE ALARM MISSING DEPRESS- AL8 MISSING DEPRESS- AL. VACUOST – AL DEPR.	EXCESSIVE OR INADEQUATE VENT PIPE LENGTH	FIREPLACE NOT COMPLIANT, MAX 6 METRES OF TUBE WITH Ø 80mm AT EACH 90° BEND OR T-CONNECTOR AS 1 METRE OF TUBE.
	CLOGGED OUTLET	CLEAN VENT PIPE / CALL AUTHORISED TECHNICIAN.
	BAD WEATHER CONDITIONS	STRONG WIND.
ALARM ACTIVE FLOW ALARM AL FLUX	SENSOR DIRTY, BARREL CLOGGED OR DOOR OPEN.	CALL TECHNICAL ASSISTANCE.
ALAR SAF FAIL THERMAL-SAFETY ACTIVE ALARM AL7 THERMAL-SAFETY AL. SAF.	BOILER TEMPERATURE TOO HIGH	LET STOVE COOL DOWN, MANUALLY RESET THERMOSTAT ON BACK. IF THE PROBLEM REMAINS UNSOLVED, CONTACT A SPECIALISED TECHNICIAN.
	TEMPORARY POWER OUTAGE	LET STOVE COOL DOWN, MANUALLY RESET THERMOSTAT ON BACK. SWITCH STOVE ON AGAIN.

	FAULTY EXCHANGER BLOWER OR BLOCKED	CALL TECHNICAL ASSISTANCE.
	FAULTY THERMOSTAT WITH RESET	CALL TECHNICAL ASSISTANCE.
	FAULTY CONTROL BOARD	CALL TECHNICAL ASSISTANCE.
ALAR SMOKE PROBE		
SMOKE PROBE ACTIVE ALARM	FAULTY FUME SENSOR	CALL TECHNICAL ASSISTANCE.
AL2 SMOKE PROBE		
AL. SMOKE P.	FUME SENSOR DISCONNECTED	CALL TECHNICAL ASSISTANCE.
ALAR HOT TEMP	FAULTY FUME SENSOR	CALL TECHNICAL ASSISTANCE.
HOT SMOKE ACTIVE ALARM	FAULTY CONTROL BOARD	CALL TECHNICAL ASSISTANCE.
	FAULTY EXCHANGER BLOWER	CALL TECHNICAL ASSISTANCE.
AL3 HOT FUMES		
AL. T. FUMES	EXCESSIVE PELLET SET VALUE AT MAXIMUM HEAT OUTPUT	CALL TECHNICAL ASSISTANCE.
WATER PROBE ALARM	WATER SENSOR FAULT	CALL TECHNICAL SUPPORT.
HOT WATER ALARM	MAXIMUM WATER THRESHOLD EXCEEDED	WAIT UNTIL THE STOVE COOLS.
WATER PRESS ALARM	HIGH OR LOW SYSTEM PRESSURE, AIR IN THE CIRCUIT	LOAD THE HYDRAULIC SYSTEM OR EMPTY IT.
TERM/DOOR SAFETY ALARM	THERMAL SAFETY THERMOSTAT OR FIRE DOOR OPEN/CLOSED INCORRECTLY	- LET THE STOVE COOL, RE-ARM THE MANUAL THERMOSTAT AT THE REAR. RESTART THE STOVE - . -CHECK THAT THE FIRE DOOR IS CLOSED CORRECTLY
ALARM AUGER TUBE TRIAC	THE BOARD DETECTS INCORRECT OPERATION OF THE PELLET LOADING MOTOR	-SWITCH THE STOVE OFF AND BACK ON - CALL TECHNICAL ASSISTANCE
ALARM ENCODER COC	SCREW FEEDER MOTOR FAULTY OR BLOCKED	CALL TECHNICAL SUPPORT.
T. card (°C)	THE TEMPERATURE OF THE BOARD HAS EXCEEDED 70°C	ALLOW THE STOVE TO COOL AND THEN TURN THE STOVE BACK ON. IF THE ALARM REAPPEARS, CONTACT TECHNICAL ASSISTANCE.
(FIELD SEARCH) REMOTE CONTROL DOES NOT CONNECT	REMOTE CONTROL HAS LOST THE UNIT	PRESS THE KEYS 1 AND 2 SIMULTANEOUSLY FOR ABOUT 3-4 SECONDS UNTIL THE "CHOOSE UNIT" APPEARS (FACTORY OUTPUT UNIT 0 DEFAULT)
	POSSIBLE INTERFERENCE	TRY DISCONNECTING FROM THE MAINS SUPPLY ANY HOUSEHOLD APPLIANCE OR ANY OTHER APPLIANCE THAT MAY GENERATE ELECTROMAGNETIC FIELDS.
REMOTE CONTROL DOES NOT SWITCH ON	DISPLAY SWITCHED OFF	CHECK BATTERY / FAULTY REMOTE CONTROL.

Date 1st maintenance _____ / _____ /

(Technical Assistance Centre stamp)

Date 2nd maintenance _____ / _____ /

(Technical Assistance Centre stamp)

Date 3rd maintenance _____ / _____ /

(Technical Assistance Centre stamp)

CERTIFICATE OF INSTALLATION AND TESTING

CUSTOMER: _____

STREET/ROAD:

CITY: _____

POSTAL CODE: _____

PROVINCE: _____

TEL: _____

Delivery date: _____

Delivery date: _____

Equipment mod.: _____

Serial number: _____ Year: _____

Retailer's Stamp:

Installer's stamp:

First name: _____

Last Name: _____

Address: _____ Postcode: _____

Location: _____

Tel.: _____

The customer acknowledges that, upon completion of the installation of the device, the works were carried out professionally and in accordance with the instructions in this user manual. The same also states that they acknowledge perfect functioning and are aware of the information needed to correctly use, operate and perform maintenance on the appliance.

CUSTOMER Signature RETAILER / INSTALLER Signature

elcofire

BEYOND EXPECTATION

Cws Complex Rock Street
V92 YH5V TRALEE IE IRELAND
Mail: sales@elcofire.com

The data and features indicated are in no way binding to Crebur LTD. The company reserves the right to make any changes necessary without prior notice or replacement.
All rights reserved. Total or partial reproduction prohibited without the express authorisation of Elcofire.