

---

# elcofire

Beyond Expectation

## Multifuel Stove

### **Elcofire Raven 5kw**



USER GUIDE

Version 1    2024.9.9

<b>Section</b>	<b>Contents</b>	<b>Page</b>
<b>1.</b>	<b>The clean air act 1993 and smoke control areas</b>	<b>3</b>
<b>2.</b>	<b>Product specification</b>	<b>4</b>
<b>3.</b>	<b>Important information about installing and using the stove</b>	<b>7</b>
<b>4.</b>	<b>Installation Instructions</b>	<b>8</b>
<b>5.</b>	<b>Operating your stove</b>	<b>11</b>
<b>6.</b>	<b>Maintenance</b>	<b>15</b>
<b>7.</b>	<b>Fault Finding</b>	<b>17</b>
<b>8.</b>	<b>CE</b>	<b>18</b>

## **1-The clean air act 1993 and smoke control areas**

---

Under the Clean Air Act local authorities may declare the whole or part of the district of the Authority to be a smoke control area. It is an offence to emit smoke from a chimney of a building, from a furnace or from any fixed boiler if located in a designated smoke control area. It is also an offence to acquire an "unauthorised fuel" for use within a smoke control area unless it is used in an "exempt" appliance ("exempted" from the controls which generally apply in the smoke control area).

In England appliances are exempted by publication on a list by the Secretary of State in accordance with changes made to sections 20 and 21 of the Clean Air Act 1993 by section 15 of the Deregulation Act 2015. Similarly in Scotland appliances are exempted by publication on a list by Scottish Ministers under section 50 of the Regulatory Reform (Scotland) Act 2014. In Wales and Northern Ireland these are authorised by regulations made by Welsh Ministers and by the Department of the Environment respectively. Further information on the requirements of the Clean Air Act can be found here:

<https://www.gov.uk/smoke-control-area-rules>

Your local authority is responsible for implementing the Clean Air Act 1993 including Designation and supervision of smoke control areas and you can contact them for details of Clean Air Act requirements.

The Elcofire Raven 5kw has been recommended for burning wood logs in a smoke control area. The Elcofire Raven 5kw must be fitted with a permanent stop preventing closure of the secondary air control/air wash control (slide plate located under the stove) beyond 5.25mm open and tertiary air controls beyond 12mm open.

THANKS FOR BUYING OUR STOVE , PLEASE READ THESE INSTRUCTIONS CAREFULLY

For your safety it is very important that your stove is correctly installed. Take care when assembling and moving the stove. It is made of steel plate and is very heavy ( 85 kgs)

This steel body with steel door stove Elcofire Raven 5kw have been recommended as suitable use in smoke control areas when burning wood and Maxibrite.

It is required by building regulations that whenever a new or replacement wood/solid fuel or biomass appliance is installed in a dwelling a carbon monoxide

## 2.Product specification

Item No.		Elcofire Raven 5kw
Weight		85KGS
4 SIDE FRAME Dimensions(WXDXH)mm		W552 X431 (max footprint/Inc handle)X683mm
3 SIDE FRAME Dimensions(WXDXH)mm		W550 X431 (max footprint/Inc handle)X613mm
Flue size		125mm
<b>Wood Logs Results, 0.83 hour refuels</b>		
Parameter		Mean
Test duration	h	0.84
Total efficiency	%	83.7
the minimum flue draught for nominal heat output	PA	12
Nominal heat output	kW	5.0
Mean CO <sup>2</sup> emission	%	12.10
Mean CO emission	%	0.13
Mean CO emission (at 13 % O <sub>2</sub> )	%	0.09
Mean CO emission (at 13 % O <sub>2</sub> )	Nmg/m <sup>3</sup>	1081
Mean flue gas temperature	°C	258
Flue gas mass flow	g/s	3.4
Mean C <sub>n</sub> H <sub>m</sub> emission (at 13 % O <sub>2</sub> )	Nmg/m <sup>3</sup>	65
Mean NO <sub>x</sub> emission (at 13 % O <sub>2</sub> )	Nmg/m <sup>3</sup>	76
DIN Plus particulates (at 13 % O <sub>2</sub> )	Nmg/m <sup>3</sup>	22

Maxibrite Results, 1.0 hour refuels		
Parameter		Mean
Test duration	h	1.01
Total efficiency	%	82.5
the minimum flue draught for nominal heat output	PA	12
Nominal heat output	kW	5.3
Mean CO <sup>2</sup> emission	%	11.11
Mean CO emission	%	0.13
Mean CO emission (at 13 % O <sub>2</sub> )	%	0.08
Mean CO emission (at 13 % O <sub>2</sub> )	Nmg/m <sup>3</sup>	1043
Mean flue gas temperature	°C	258
Flue gas mass flow	g/s	3.4
Mean C <sub>n</sub> H <sub>m</sub> emission (at 13 % O <sub>2</sub> )	Nmg/m <sup>3</sup>	65
Mean NOx emission (at 13 % O <sub>2</sub> )	Nmg/m <sup>3</sup>	76
DIN Plus particulates (at 13 % O <sub>2</sub> )	Nmg/m <sup>3</sup>	39

Elcofire Raven 5kw

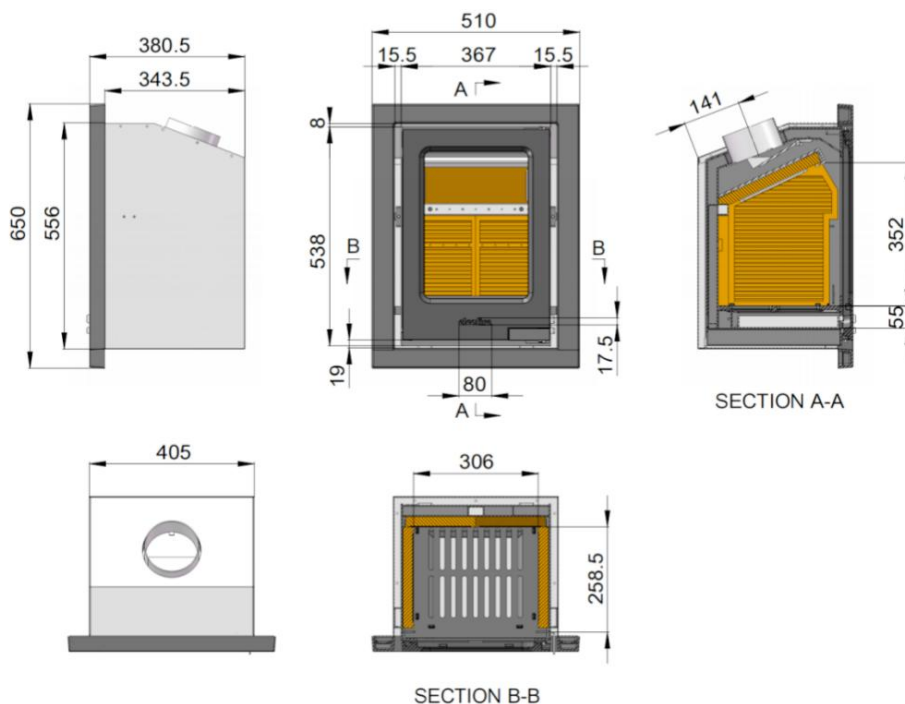

Please note that Building Regulations Document J advises that additional permanent air supply is required for appliances with an output of above 5Kw.

With modern properties additional air may be required as Document J suggests that additional air would be a benefit.

 If design air permeability  $\geq 5.0\text{m}^3/(\text{h}\cdot\text{m}^2)$  then  $550\text{mm}^2/\text{kW}$  of appliance rated output above 5kW

Or

 If design air permeability  $\leq 5.0\text{m}^3/(\text{h}\cdot\text{m}^2)$  then  $550\text{mm}^2/\text{kW}$  of appliance rated output  
If in doubt, please consult your registered installer for advice.

Please note that details and specifications contained herein are correct at the time of going to print. We reserve the right to change specifications at any time without prior notice.

### 3. Important information about installing and using the stove

---

Since April 2002 only registered competent installers can install solid fuel appliances. Installations carried out by non-registered installers must be inspected by local authority building control. For more information please contact hetas at: [www.hetas.co.uk](http://www.hetas.co.uk) or telephone: 0845 6345626



All national and local regulations, including those referring to national and European standards, need to be complied with when installing the stove.



The stove must be installed by a registered installer or approved by your local building control officer.



All the instructions in this manual should work in conjunction with building regulations document J, if there is a variation the most stringent requirement should be adhered to.



Only use for domestic heating purposes only.



Do not operate this appliance if it becomes damaged.



Improper use, maintenance or fitting parts other than those approved by the manufacturer could lead to the appliance becoming damaged or unsafe which in turn could lead to personal injury or damage to the property and will void the warranty.



The appliance should be inspected regularly to ensure the airways are clean and free from obstruction and the chimney swept at least once a year.



The external surfaces of this appliance will be very hot to the touch when in operation and due care will need to be taken when operating the appliance to ensure safety. A fire guard should be fitted if it is likely that the elderly, infirm or children may come into contact with the appliance.



This stove will become very hot whilst in operation and due care should be taken. Thick gloves should be used to operate the primary/secondary controls or reaching inside the stove to position fuel or remove ash. Do not place flammable objects on or near the stove.



Burn only approved fuels (Wood or manufactured smokeless fuel). Do not use petroleum based products or use as an incinerator.



It is possible to fire the stove beyond its design capacity. This could damage the stove, so watch for signs of overfiring - if any part of the stove starts to glow red, the stove is in an overfire situation and the controls should be adjusted accordingly. Never leave the stove unattended for long periods without first adjusting the controls to a safe setting. Careful air supply control should be exercised at all times.



The stove must NOT be installed into a chimney that serves any other appliance and is suitable for intermittent burning.



Do not make unauthorised changes or modifications to the stove.



This appliance may contain sharp metal edges, take care when installing or servicing this appliance to avoid personal injury. Please use appropriate personal protective equipment at all times.



The requirements for the supply of combustion air, for the simultaneous operation with other appliances and for the operation of exhaust air devices; NOTE  
Extractor fans when operating in the same room or space as the appliance, may cause problems.

## 4. Installation Instructions

**Warning: Due to the weight of the stove it is recommended that two people perform the unpacking and assembly**

### Unpacking

Before assembling, please check contents against the following list and advise your dealer immediately if any parts are missing.

- 1 x Stove body
- 1 x Flue Connector c/w Fireproof Gasket
- 1 x Firebox Top Baffle Plate A
- 1 x Firebox Top Baffle Plate B
- 1 x Ash pan & Handle
- 1 x Grate
- 1 x Fixing Kit
- 1 x Heat Resistant Glove
- 1 x Vermiculite plate set

### Location of the unit

The appliance must stand on a noncombustible constructional hearth which is at least 125mm thick with the minimum dimensions as shown in the opposite diagram (please see Building regs. Document J for further information).

If the appliance is to be fitted in a raised application, due consideration should be



given to extending the depth of the superimposed hearth to safely contain any falling embers or logs. The hearth and building construction must be of a suitable material to comply with current building and local authority regulations. The fabrication of the construction must have a suitable load bearing capacity for the appliance and hearth.

If in any doubt, please consult a competent person for advice before proceeding.

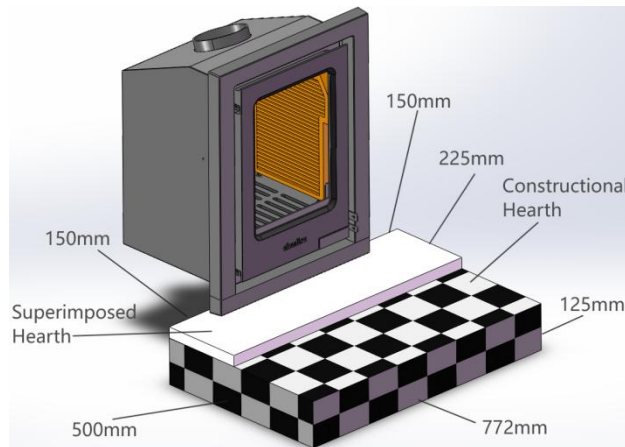

## Minimum Builders Opening

For ease of installation the builders opening may be made slightly larger than the appliance dimensions. The construction of fireplace recess should be of a suitable non-combustible material such as brick or concrete blockwork, and have a minimum thickness of 200mm to the sides and rear of the appliance, unless it is a back to back recess within the same property. Please refer to building regs document J for more information.

## Material Clearances

The stove must have a minimum clearance to a combustible below.

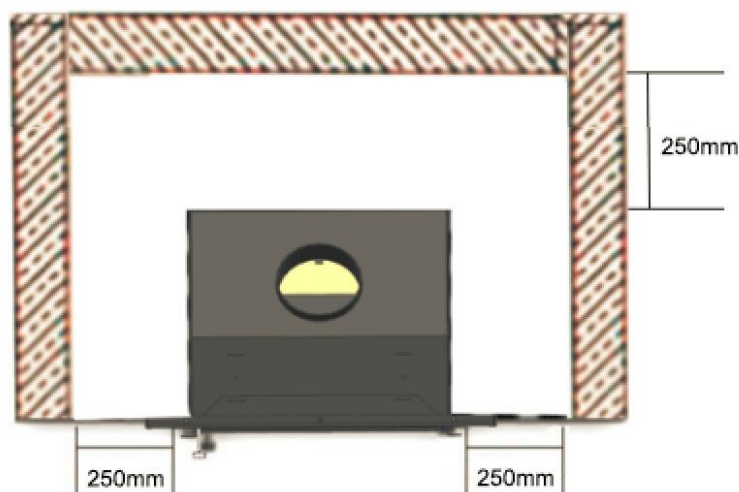

Do not use combustible materials within the white area (250mm to the sides of the appliance and 250mm to the rear of the appliance).

Do not fill the area surrounding the appliance with insulating material, the void around the appliance must be ventilated to prevent a buildup of excess heat.

There must be minimum ventilating area at both high and low levels of 50 cm<sup>2</sup> each, the vents should take ambient air from the room in which the appliance is installed and return the warm air back into the same room environment. Consideration should also be taken to provide adequate access to the connecting flue for service and maintenance purposes.

## Installation into a wooden decorative fireplace

Installation into a wooden decorative fireplace

If the appliance is to be fitted in conjunction with a combustible fire surround the minimum clearances must be maintained, please see diagram opposite (250mm to the sides and 500mm above to combustible shelf) these dimensions should be adhered to from any point of the appliance to any combustible material. If granite, stone, marble or any other non-combustible decorative material is to be used as a superimposed hearth and back panel provision should be made for heat and expansion. The use of a slabbed and split back panel and hearth is recommended, if in doubt please seek the recommendation of a competent person or manufacturer of the above mentioned product. Curtains and soft furnishings should be a minimum of 1m away from the appliance. We do not recommend that plasma televisions and expensive artwork are hung over the fireplace.

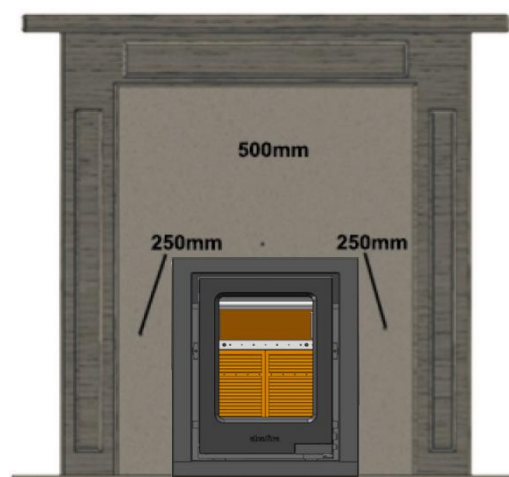

## Flue Requirements

The flue must comply with current Building Regulations Document J.

The construction of masonry, flue block, insulated flue systems and flexible flue liners must comply with the manufacturers instructions at all times.

The flue must be:

! Suitable for use with solid fuel burning appliances

! Be able to clean the entire length of the flue system without removal of the appliance



Well insulated

 At least 4m in height from hearth level to termination, with no more than 4 x 45° bends in any one flue system and have a maximum horizontal length of no more than 20% of the overall vertical height

 The termination should be sited as to avoid a negative pressure zone

---

**WARNING:**

 The flue cannot shared with other appliances and cannot weight bearing on the appliance

---

## 5. Operating your stove

---

 Always ensure that the ash draw is fully located before operation of the appliance

To allow the appliance to bed in, and fixing glues and paint to fully cure, only fire the appliance using kindling and just get hot for at least three fires.

Before lighting the next small fire please allow the appliance to return back to room temperature.

During these first small fires you may experience a haze and unpleasant smell as the paint cures, do not touch the paint and keep the room well ventilated.

Please note that during the first firing, we recommend a small fire is lit and that you slowly increase the temperature to enable the various parts to expand normally.

You may also experience fumes and a haze being given off by the stove during the first firing and possibly for the next couple of firings as the paint cures. This is normal but please ensure that the room is well ventilated during this period.

The appliance should not be operated in mild weather with smokeless fuel. Under certain weather circumstances e.g. fog the chimney will not draw sufficiently and could cause asphyxiation. Either await better weather conditions or burn wood only. If the appliance has overheated, the appliance and flue will need to be inspected for any damage before it can be operated again.

## Recommended Fuels

Wood: hardwood such as ash, oak and beech which have been cut for at least 2 years and stored under shelter. The logs should have a maximum moisture content of 20%. Maximum log length 270mm, maximum width 135mm.

Smokeless Fuels: below 20% Petroleum coke content such as Anthracite, Phurnacite, Maxibrite suitable for use with a closed heating appliance.

---

**Warning:**



DO NOT BURN wet or unseasoned wood, construction timber, painted or treated wood, driftwood or manufactured board products. Doing so will result in the wood burning inefficiently and excess smoke, soot and tar will be produced. This will coat and damage the internal components of the stove and flue and could result in a chimney fire.

---

## Instructions for use with wood

Open the secondary air slider to the left hand side of the door, and open the primary air slider to the right hand side of the door by fully pulling the levers outwards.

Lay firelighters or rolled up newspapers on the grate and add a small amount of kindling wood to the top. Place 1 or 2 small logs on the top.

Light the newspaper or firelighters using a long taper and push the door closed but do not engage the locking handle fully.

When the fire is burning fiercely, after a couple of minutes add more logs and close the door.

When the fire has become established, close the primary air, to the right hand side of the door, by pushing the lever fully inwards.

The burning rate can be altered by moving the secondary air slider, to the left hand side of the door - push the lever inwards to close down and pull the lever outwards to increase the burn rate.

Care should be taken to ensure that the logs are not placed where there is a danger that they may fall onto the glass or out of the chamber when the door is opened.

Never load logs into the appliance that are oversized or too long for the combustion chamber, they could press against the glass and cause damage when alight. The maximum log length is 270mm.

---

**WARNING:**



When opening the door always open gently for the first 2 to 3 cm to allow the pressure to equalise and stop smoke from escaping. The stove should not be

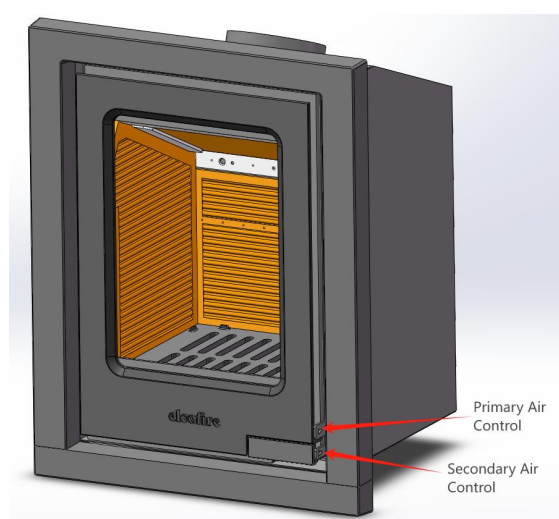

operated with either door left open for long periods. The stove door should never be left open when the stove is in use.

---

## Instructions for use with smokeless fuel

Open the secondary air slider to the left hand side of the door, and open the primary air slider to the right hand side of the door by fully pulling the levers outwards.

Lay firelighters or rolled up newspapers on the grate and add a small amount of kindling wood to the top. Place a small quantity of smokeless fuel on top.

Light the newspaper or firelighters using a long taper and push the door closed but do not engage the locking handle fully.

When the fire is burning fiercely, after a couple of minutes add more smokeless fuel and close the door.

When the fire has become established, close the secondary air to the left hand side of the door, by pushing the lever inwards.

The burning rate can be altered by moving the primary air slide to the right hand side of the door - push the lever inwards to close down and pull the lever outwards to increase the burn rate.

Care should be taken to ensure that the firebox is not overfilled with smokeless fuel - it should be no higher than the log guard.

## Re-fueling

Always refuel onto hot embers. If there is insufficient burning material in the firebed to light a new fuel charge, excessive smoke emission can occur. Refuelling must be carried out onto a sufficient quantity of glowing embers and ash that the new fuel charge will ignite in a reasonable period. If there are too few embers in the fire bed, add suitable kindling to prevent excessive smoke.

 Directly after re-fuelling, it was necessary to operate with the door ajar for a period of 3 minutes in order to maintain flames on the new re-fuel charge.

---

Do not leave the fire unattended until the flames are well established on the newly charged logs

It is important to follow these instructions in order to achieve clean burning and to maximise the efficiency of the stove.

---

The stove must not be overloaded with fuel. Overloading can cause excess smoke. Following the above procedure will maximise the performance of the stove. Typically, the four logs will burn with an attractive flame pattern and will last for about an hour (although this will depend on weather conditions, e.g. whether it is windy, and specific installations, e.g. chimney dimensions)

Operation with the door open can cause excess smoke. The appliance must not be operated with the appliance door left open except as directed in the instructions.

Operation with the air controls or appliance dampers open can cause excess heat within the appliance. The appliance must not be operated with air controls, appliance dampers or door left open except as directed in the instructions.

## **Glass**

Never operate the appliance if the glass panel is broken or cracked. This can cause the appliance to overfire, which may damage the appliance and flue system and may cause a danger to persons and property. Only use once the glass is replaced and the sealing gaskets checked for integrity, only replace with a manufactures approved glass.

## **Fume Emissions**

To avoid chimney problems, your fire should not be burnt slowly for longer than 12 hours without a period of fast burning.

Properly installed and operated, this stove will not emit fumes. Occasional fumes from de-ashing and refueling may occur. Persistent fume emission must not be tolerated. If fume emission persists, the following immediate action should be taken:

1. Open doors and windows to ventilate room.
2. Let the fire out, or eject and safely dispose of fuel from the stove.
3. Check for flue chimney blockage and clean if required.
4. Do not attempt to re-light the fire until the cause has been identified and corrected.

If necessary, seek professional advise.

## **De-ashing the stove**

Before de-ashing the stove, make sure that all the fuel has burned out and the ashes has cool down, then use a brush let the ash fall from bed of the fire into the ash pan underneath. Then take out of the ashpan .in this case, if you have the vacuum cleaner,

Sucked the ask into the vacuum cleaner directly.

If the stove is still burning when you want to de-ash the stove, make sure that you take a heat resistant glove and use special tools for cleaning. Brush and vacuum cleaner are not suitable in this case.

### **WARNING**



Take great care when removing and emptying the ash pan. It may be very hot and still contain burning or smouldering embers and is a fire risk.

---

## **Adverse weather conditions**

In a small number of installations, very occasionally in specific weather conditions (direction of wind) the draw of the chimney may be affected causing a downdraught and fumes to be emitted into the room.

If this is the case the stove should not be used and advice sought from a professional flue installer who would be able to advise on possible solutions such as an anti-downdraught cowl.

## **6.Maintenance**

---

### **Daily Maintenance**

The grate should be cleaned regularly and the ash pan emptied daily. Never allow the ash in the ashpan to overfill allowing ash to be in contact with the underside of the grate. This will overheat the grate and cause premature wear and distortion.

The glass can be cleaned using a soft damp cloth or a stove glass cleaner (available from your local stockist).

Do not clean the glass of your stove with abrasive cleaners or scratch pads as this may damage the surface of the glass causing it to weaken and wear prematurely.

Never allow the door gasket to become wet when cleaning the glass, this will deteriorate the gasket prematurely.

### **Periodic Maintenance**

The chimney should be swept at least once a year together with the flue pipe connection. Care should be taken to ensure that there is not a build up of soot on the baffle and in the airways of the appliance.

If the appliance has not been operated for long periods, the flue should be inspected

and swept before use to ensure there are no blockages within the flue.

The internal vermiculite panels of the appliance should be checked regularly for soundness. If any wear and tear is found, we recommend these parts are replaced immediately.

Check the rope door seals are intact and are not worn. These should be replaced on an annual basis to ensure the correct operation of this appliance.

Is advisable as part on the periodic maintenance of your appliance to lubricate the moving parts of your stove i.e. handle, air sliders, door hinges, with a suitable high temperature lubricant this will ensure the correct operation of your appliance.

It may be necessary to adjust to tension of the door closing mechanism during the lifetime of the appliance as the sealing rope will compress over time, this is achieved by the adjusting the bracket on the body of the stove to the required tension.

## **Summer**

When the stove is not going to be used for long periods e.g. the summer months, we recommend that you keep the air slides fully open and the door slightly ajar if possible. This will help to prevent condensation which may in turn lead to internal corrosion of component parts.

## **Stove glass**

Clean any glass panels when cool, avoiding abrasive substances which could scratch the glass and make subsequent cleaning more difficult. Wet logs against a heated glass, a badly aimed poker or heavy slamming of the doors could crack the glass panels. The glass will not fracture with heat. Never replace any broken glass with glass not approved for use with cast iron stoves.

The window glass should remain clean during normal use but it can become blackened if the stove is being operated with either damp fuels or at a slow burn rate. The blackening may be dispersed by burning firefly at a much higher temperature, or it may be cleaned off using specialist glass cleaner.

In the event of the glass being broken, it can be removed by unscrewing the retaining clips, taking care not to damage the fireproof seal. The replacement glass should be carefully placed against the seal and the retaining clips re-tensioned. Take care to tension these evenly or there is a risk of breaking the new glass pane.

## **Chimney**



It is important to have the chimney cleaned at least once a year.  
Regular inspection and cleaning of the internal components of the stove can indicate if the chimney requires more frequent cleaning.

If the stove has been unused for an extended period (during the summer) the chimney should be checked by a competent person before use.

#### Note

All parts that are in direct contact with the fire (grate, Baffle, back or side air boxes) are considered as normal wear parts. Their life will be depend on how vigorously the stove is operated and they must be inspected and maintained on a regular basis. If they become worn, damaged or not positioned correctly, non wear parts such as the stove top and sides will be exposed to excessive heat and may be damaged. Only use replacement parts recommended by the manufacturer.

## Chimney fire

In the event of a chimney fire:

- Shut all air controls immediately
- Raise the alarm and evacuate the building
- Call the fire brigade

Do not re-enter the building

## 7.Fault Finding

---

### Fire will not burn

- The fuel is too wet and not suitable
- Air inlets to the stove are blocked
- The flue is blocked or restricted
- Inadequate air supply into the room

### Soot build up on glass



- Fuel is too wet
- Fuel pieces are too large and “smouldering” rather than burning.
- The stove operating temperature is too low
- The stove is being run too “slow” with not enough air
- Poor chimney draft

### Excessive wear on internal parts

- Stove fired too vigorously
- Too little air passing through the bottom grate
- Use of wood that is too dry (eg wood from old furniture)

## 8.CE

---

   EN 13229: 2001 / A2:2004  
Roomheater fired by solid fuel

Roomheater type	Elcofire Raven 5kw
Defra Approved Wood Burning Stove	
Fuel types	Wood, Manufactured Smokeless Fuel
Nominal heat output	
Wood	5.0KW
Manufactured Smokeless Fuel	5.0KW
Total net energy efficiency	
Wood	83.7%
Manufactured Smokeless Fuel	82.5%
Distance to adjacent combustable materials	
Side Mantel	250 mm
Top Mantel	500 mm
Front Wall	1200 mm
Emission of CO in combustion products (13% O <sub>2</sub> )	
Wood	0.09%
Manufactured Smokeless Fuel	0.08%
Flue gas temperature	
Wood	258°C
Manufactured Smokeless Fuel	258°C

The appliance is capable of intermittent operation  
The appliance cannot be used in a shared flue  
Follow the users manual and only use recommended fuel

---

Elcofire Ireland 2022  
Cws Complex Rock Street Tralee Co. Kerry

# elcofire

Beyond Expectation

Cws Complex Rock Street Tralee

Co. Kerry, Ireland

Tel: 066 4018110

[www.elcofire.com](http://www.elcofire.com)